

SAW Bandpass Filter 230551B



1. Features

- IF Bandpass Filter
- Low-Loss Filter
- Single-Ended Operation
- Ceramic Surface Mount Device (SMD) Package
- Maximum Storage Temperature Range : -40 °C ~ 85 °C
- Electrostatics Sensitive Device (ESD)

2. Package Dimensions

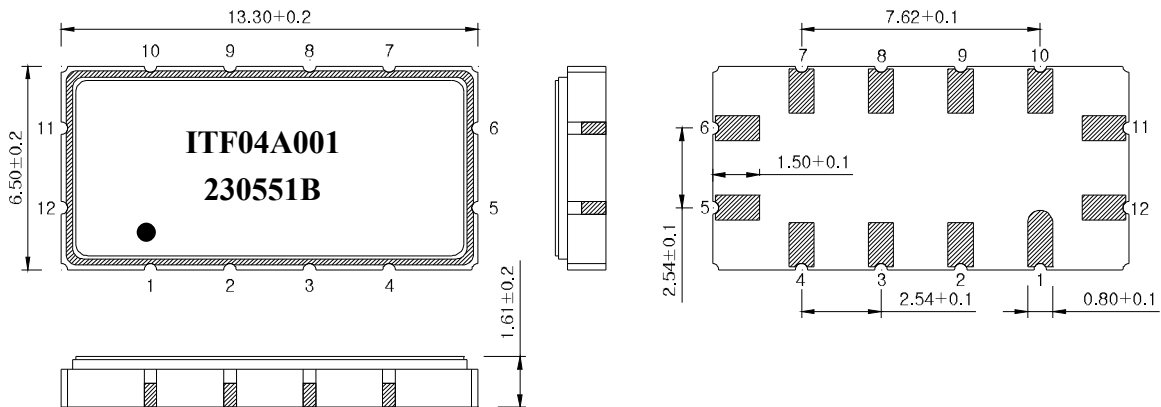

Package : S1365

Dimensions shown are nominal in millimeters

Body : Al₂O₃ Ceramic

Lid : Kovar, Ni Plated

Terminations : Au plating 0.3 ~ 1.0 um, Over a 1.27 ~ 8.89 um Ni Plating

Pad Configuration	
11	Input
5	Output
6, 12	Ground
Other	Case ground

	ITF Co., Ltd. 102-901, Bucheon Technopark 364, Samjeong-Dong, Ojeong-Gu, Bucheon-City, Gyeonggi-Do, Korea 421-809	Part No.	230551B	
		Rev. Date	2004-06-24	
		Rev.	NJ4009-CS01	1/5

SAW Bandpass Filter 230551B



3. Specifications

F_o = 75.0 MHz

Terminating source impedance : 50Ω and matching network

Terminating load impedance : 50Ω and matching network

Operating Temperature Range : -30℃ ~ +85℃		Minimum	Typical	Maximum
Center Frequency	MHz	74.4	75.0	75.6
Insertion Loss	dB	-	7.0	9.0
1dB Bandwidth	MHz	4.7	4.8	-
3dB Bandwidth	MHz	5.4	5.6	-
40dB Bandwidth	MHz	-	7.9	8.5
Amplitude Ripple (F _o +/- 1.8 MHz)	dB	-	0.6	1.0
Group Delay Variation (F _o +/- 1.8 MHz)	nsec	-	90	140
Absolute Delay	usec	-	1.23	1.5
Ultimate Rejection	dB	40	45	-
Temperature Coefficient of Frequency	ppm/℃	-	-86	-

Room temperature : +25℃		Minimum	Typical	Maximum
Center Frequency	MHz	74.8	75.0	75.2
Amplitude Ripple (F _o +/- 3.2 MHz)	dB	-	0.6	1.0
Group Delay Variation (F _o +/- 3.2 MHz)	nsec	-	90	140

Notes :

- 1) All specifications are based on the matching schematic shown below
- 2) All specifications are measured by Agilent Network analyzer and full 2 port calibration
- 3) Electrical margin has been built into the design to account for the variations due to temperature drift and manufacturing tolerances
- 4) All attenuation measurements are measured relative to insertion loss

	ITF Co., Ltd. 102-901, Bucheon Technopark 364, Samjeong-Dong, Ojeong-Gu, Bucheon-City, Gyeonggi-Do, Korea 421-809	Part No.	230551B	
		Rev. Date	2004-06-24	
		Rev.	NJ4009-CS01	2/5

SAW Bandpass Filter 230551B



4. Matching Schematic

(Actual matching values may vary due to PCB layout and parasitics)

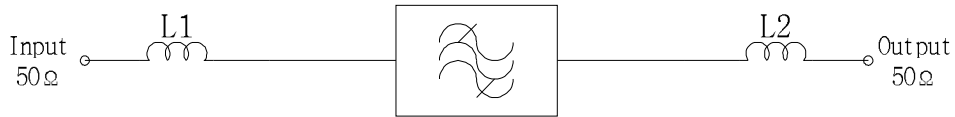

$$L1 = L3 = 82 \text{ nH}$$

$$L2 = 150 \text{ nH}$$

5. Marking Configuration

ITF¹⁾ 04A001²⁾

230551B³⁾

●⁴⁾

1) Manufacturer name

2) Lot Number

3) Part Number

4) Pad Number 1 Index

	ITF Co., Ltd. 102-901, Bucheon Technopark 364, Samjeong-Dong, Ojeong-Gu, Bucheon-City, Gyeonggi-Do, Korea 421-809	Part No.	230551B	
		Rev. Date	2004-06-24	
		Rev.	NJ4009-CS01	3/5

SAW Bandpass Filter 230551B



6. Typical Performance (at +25°C)

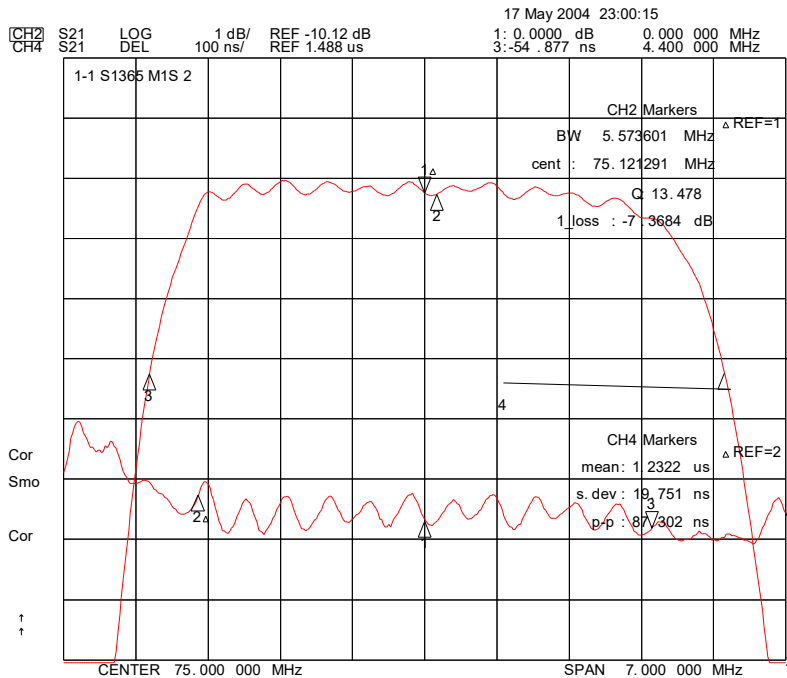
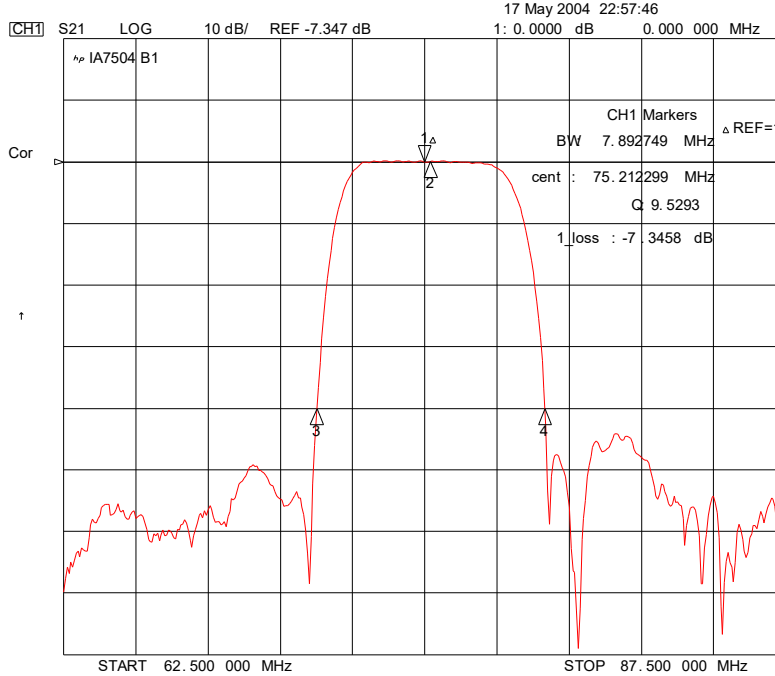

	ITF Co., Ltd. 102-901, Bucheon Technopark 364, Samjeong-Dong, Ojeong-Gu, Bucheon-City, Gyeonggi-Do, Korea 421-809	Part No.	230551B	
		Rev. Date	2004-06-24	
		Rev.	NJ4009-CS01	4/5

SAW Bandpass Filter 230551B

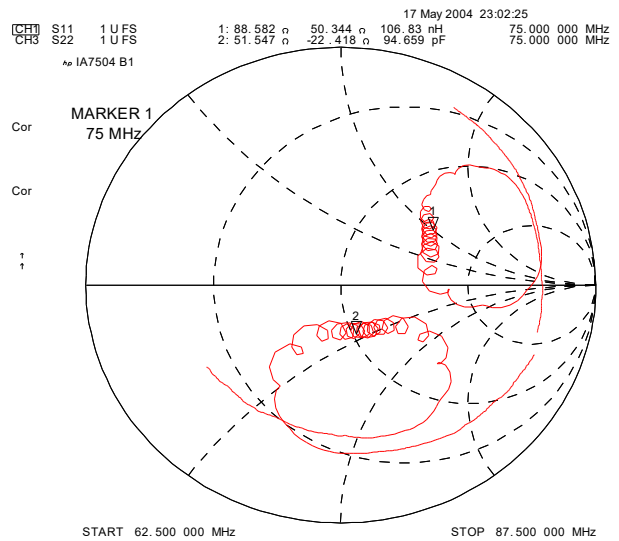
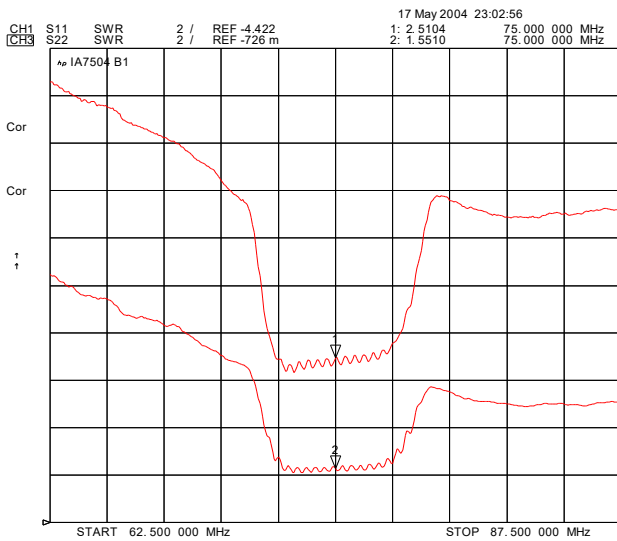
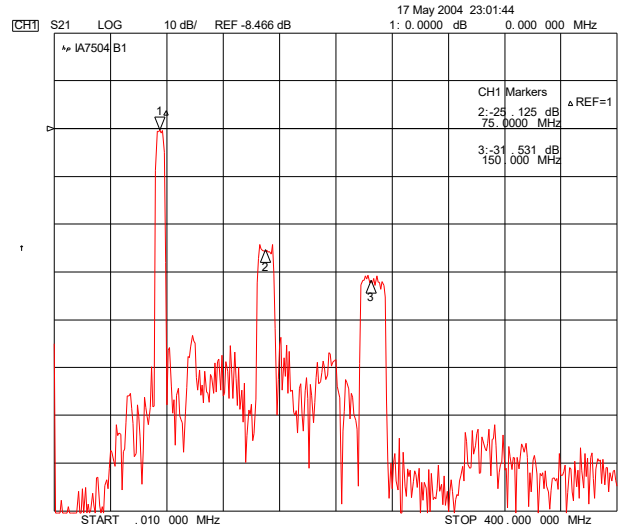
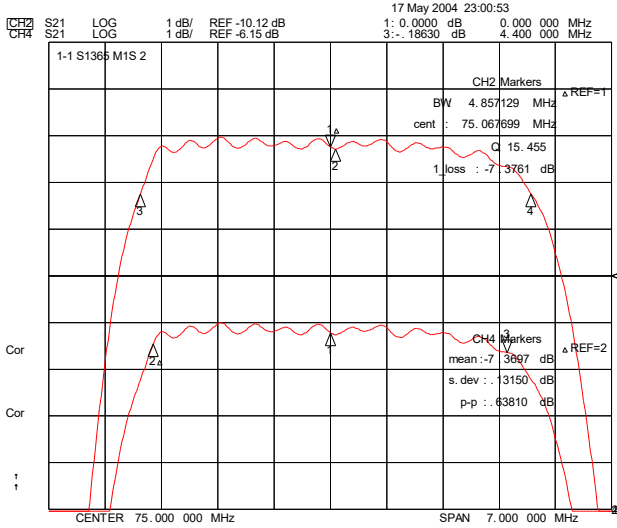

ITF Co., Ltd.
102-901, Bucheon Technopark 364,
Samjeong-Dong, Ojeong-Gu, Bucheon-City,
Gyeonggi-Do, Korea 421-809

Part No.	230551B	
Rev. Date	2004-06-24	
Rev.	NJ4009-CS01	5/5